



Alginates

Guideline for taking perfect situation impressions.

Giving a hand to oral health.



KULZER
MITSUI CHEMICALS GROUP

Content

1. Introduction	4
2. Indications for alginate situation impressions	5
3. Alginate materials	6
3.1 Composition	6
3.2 Setting reaction	6
3.3 Material properties	7
4. Correct storage of alginate powder	8
5. Procedure with alginate impressions	9
5.1 Selecting the impression tray	10
5.2 Dispensing and mixing	11
5.3 Taking and removing the impression	11
5.4 Special features with colour-change alginates	12
5.5 Assessing and preparing the impression	12
6. Model fabrication	14
6.1 Required materials	14
6.2 Preparing the impression	15
6.3 Mixing the dental gypsum	15
6.4 Pouring the impression	16
6.5 Removing the impression from the model	16
6.6 Trimming the model	17
7. References	17
8. Troubleshooting	18

1. Introduction

Anatomical models, which accurately reproduce the shape of the teeth and adjacent jaw sections, are used for many diagnostic and treatment purposes in the dental practice. A dimensionally accurate impression, i.e. a negative mould of the jaw, is essential for fabricating a precise anatomical model. The most commonly used material for situation impressions is alginate, as it produces models with an acceptable degree of accuracy, is easy to use and cost-effective in comparison with other impression materials.

This depends, however, on correct storage of the alginate and usage of the correct technique. This booklet is intended to provide information on the procedure of alginate impression taking and subsequent model fabrication by depicting it step-by-step.

In addition, the booklet includes information on possible errors during impression taking and subsequent model fabrication as well as information on error prevention.

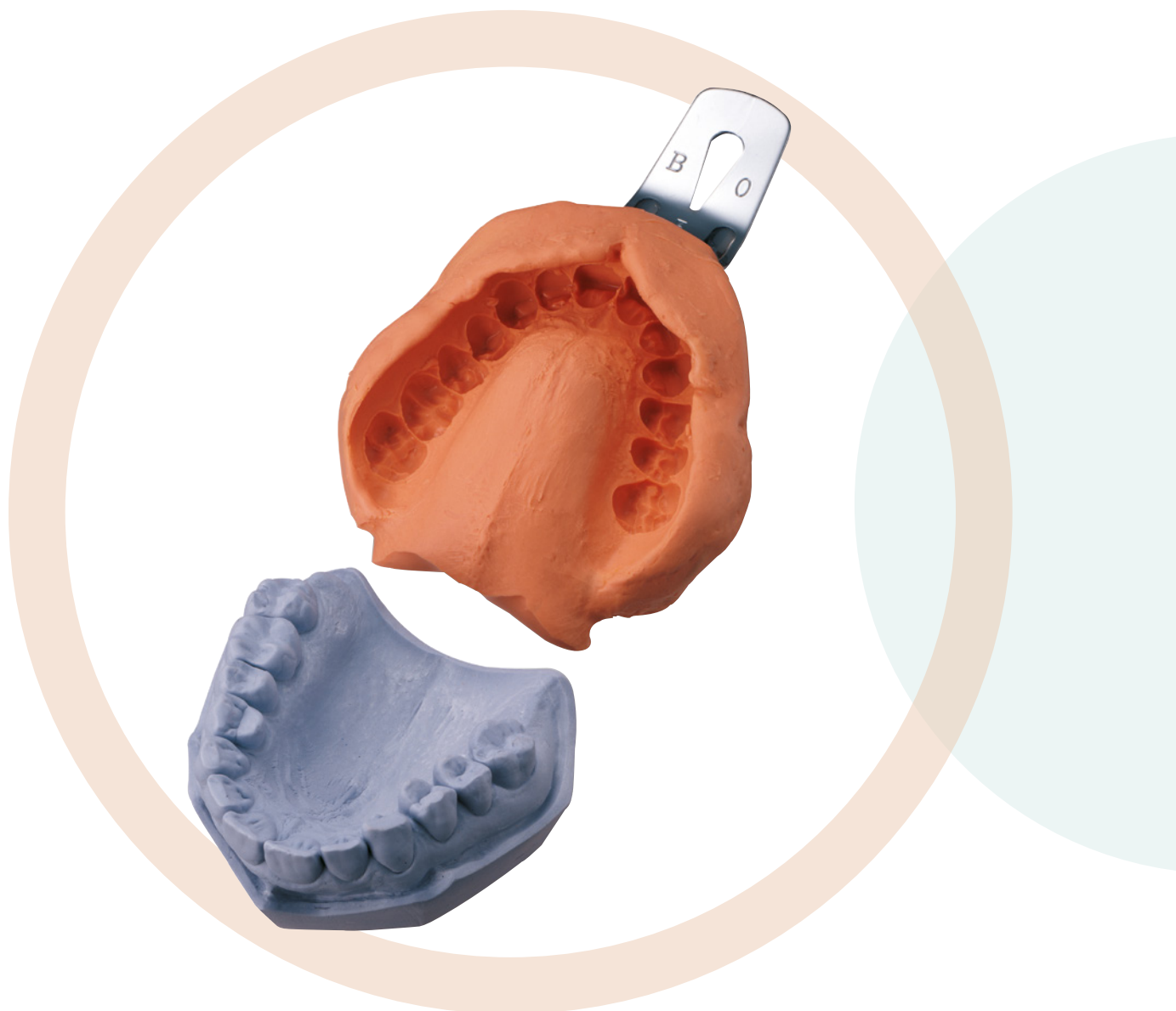

2. Indications for alginate situation impressions

Alginate situation impressions have a wide range of indications including fully dentulous, partially dentulous and fully edentulous jaws. Anatomical models fabricated from alginate impressions can fulfill various functions.

As study models, they reproduce the current status of the dentition. They can be used, amongst others, to monitor the ongoing situation during orthodontic treatment or to compare the status of the dentition before and after prosthetic treatment.

As analysis models, articulated anatomical models can be used to check the occlusion. Occlusal interferences might be more easily detected on articulated models than directly in the mouth. Any extensive grinding adjustments can initially be simulated on the analysis model.

As planning models, anatomical models are generally essential for extensive prosthetic restorations. Different treatment options can be simulated on the model and allow the dentist, together with the patient, to select the correct treatment for the individual case.

As an opposing model, the anatomical model reproduces the occlusal contour of the opposing dentition when fabricating indirect restorations or other treatment appliances that are fabricated on a model.

As working models, anatomical models poured from an alginate impression are used for fabricating e.g. partial cast dentures, simple clasp-retained acrylic dentures or removable orthodontic appliances. Working models can also be used for fabricating custom impression trays and bite blocks, or for repairs.

3. Alginate materials

3.1 Composition

Alginates belong to the group of irreversible, elastic impression materials. The raw material is extracted from seaweed (lat. alga = seaweed) and is supplied in powder form.

Alginate powder contains easily water-soluble sodium or potassium salts of alginic acid, calcium sulphate as a second reaction component and sodium phosphate as retarder. Inorganic fillers (e.g. talc, zinc oxide, diatomaceous earth) make up the biggest proportion of powder by mass and determine the flow properties of the mixed alginate as well as increase the strength of the set alginate. Traces of pigments and flavouring agents are additionally added to the alginate powder as well as fluorides, which improve the surface quality of the model.

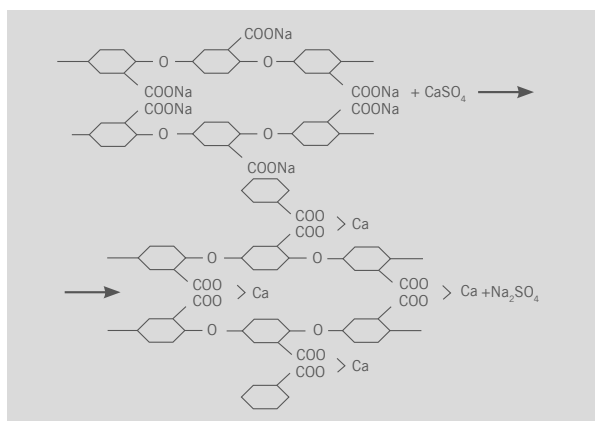

Fig. 1: Setting reaction of the alginate impression material. If bivalent metal ions (Ca^{2+}) are present, cross linking of the single-chain, water-soluble alginate molecules occurs when dissolved in water; Ca alginate is produced, which is insoluble in water.

3.2 Setting reaction

In contrast to the easily water-soluble salts of alginic acids with monovalent metal ions (e.g. Na^+ in sodium alginate), the salts of alginic acids with bivalent metal ions (e.g. calcium ions Ca^{2+}) have a very low solubility, as a cross-linking reaction between the polymeric alginic acid molecules occurs.

If water is added to the alginate powder, which contains the easily soluble sodium salts of alginic acid and calcium sulphate as reactants, the two reactants dissociate into their individual components: (i.e. sodium alginate dissociates into sodium ions and alginic acids, and calcium sulphate dissociates into calcium and sulphate ions). The alginic acid can now react with the released calcium ions (Fig. 1). Due to cross-linking of the long-chain alginic acid molecules an elastic gel forms and the material solidifies.

As this reaction proceeds very fast, retarders are added to the alginate powder to allow an adequate working time. The retarder, e.g. sodium phosphate (Na_3PO_4) initially binds the majority of the calcium ions (Ca^{2+}) released from the calcium sulphate (CaSO_4) and precipitates them as low-soluble calcium phosphate. The setting reaction of the alginate is only fully initiated once the retarder is completely used up. By regulating the amount of added retarder, the manufacturer can determine the setting time of his product.

Alginates can be classified as fast set and regular set (see Table 1). As with all chemical reactions, the setting speed of alginate materials is also greatly affected by temperature. The setting reaction can therefore be retarded by using cold water and accelerated by using warm water.

Product overview alginates

	xantalgin Crono	xantalgin Select Fast Set	Alginoplast Regular Set	Alginoplast Fast Set
Consistency	creamy	creamy	firm	firm
Working time	1:15 min	1:00 min	1:30 min	1:00 min
Intraoral setting time	1:00 min	1:00 min	1:30 min	1:00 min
Setting time	2:15 min	2:00 min	3:00 min	2:00 min
Mixing ratio (powder : water)	23 g : 50 ml	21 g : 50 ml	23 g : 50 ml	23 g : 50 ml
Flavour	peppermint	peppermint	peppermint	peppermint

Tab.1: Different types of alginates

Test complies with ISO 1563



3.3 Material properties

Fluidity

The fluidity, i. e. viscosity of the alginate mixture is greatly influenced by the amount of water added for mixing. It is therefore important to adhere strictly to the dosage ratio of powder and water prescribed by the manufacturer.

Detail reproduction

The accuracy of detail reproduction of alginate impressions is determined by the grain size of the filler particles and type of polymeric macromolecules. Thus, minor differences between individual manufacturer's products are possible but usually not clinically relevant. The resolution limit for accurately reproducing fine structures with alginate impressions is approx. 50 µm (according to ISO 1563). As alginate materials reproduce details less accurately than other elastic impression materials, they cannot be used for working models intended for the fabrication of, e.g. inlays, crowns or bridges.

Dimensional characteristics

The water molecules between the macromolecules of the set alginate impression material are loosely bound. Thus, water can be easily released or absorbed, depending on whether the alginate impression is stored dry or moist. This results in shrinkage or swelling of the alginate and consequently in dimensional changes. It is therefore essential to pour alginate impressions with plaster as soon as possible. The latest development in alginate materials is a product that allows impressions to be stored up to five days without any clinically relevant dimensional changes, provided they are stored correctly.

Elastic properties

Due to its cross-linked structure, alginate material is elastic when set and suitable for reproducing undercut areas. However, its recovery from deformation is lower than that of hydrocolloids. At 50 % compression and under relatively little tensile stress, the alginate impression tears. Areas with severe undercuts such as wide interdental areas or areas below self-cleansing bridges should therefore be blocked out with wax intraorally prior to impression taking. Care should also be taken to ensure a minimum layer thickness of at least 5 mm between dentition and tray wall. Plastic impression trays should not be used, as such a high elastic deformation occurs during impression removal, that it results in insufficient recovery and thus a permanent plastic deformation of the impression.

Disinfection

A particular difficulty when disinfecting alginate impressions is that they can only be immersed in aqueous solutions for a short period of time without swelling due to their high water absorption capacity and the resulting dimensional changes. However, it is possible to disinfect alginate impressions effectively in a few minutes without impairing their quality by using adequate disinfectant solutions and observing the instructions for use.

4. Correct storage of the alginate powder

Alginate powder can be stored in the original packaging for up to three years at room temperature (23°C). It is therefore important to check the fabrication and expiry dates on the packaging when purchasing alginate.

Once the packaging has been opened, the alginate powder container must always be properly closed after dispensing material. Adhere to the relevant storage conditions given in the instructions for use.

Always dispense alginate powder from the packaging using a dry instrument.

Never dispense the powder from the container with a moist spatula or remove excess powder from the dispensing scoop with a moist spatula.

The alginate container should be thoroughly shaken at the beginning of each working day. This loosens the powder that has been compacted during storage and ensures it can be dispensed according to the instructions for use.



5. Procedure with alginate impressions

Different shapes of impression trays



(a)
for fully dentulous jaws



(b)
for partially dentulous jaws

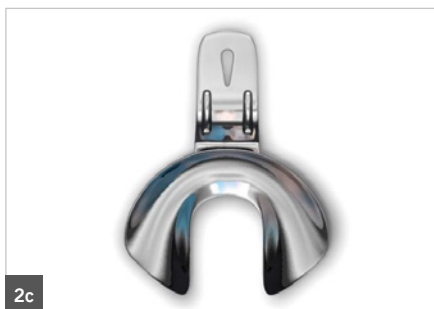

(c)
for edentulous jaws.

5.1 Selecting the impression tray

An impression tray is required as a carrier for the impression material.

Stock impression trays are available for fully dentulous, partially dentulous and fully edentulous jaws. The trays are supplied in different sizes, marked on the handle of the tray, and in various designs (Fig. 2 a–c).

Basically, it can be differentiated between trays made of metal or plastic and either unperforated or perforated ones.

The advantage of **metal trays** is that they can be sterilized.

In contrast, **plastic trays** are normally intended for single use only and can have the disadvantage of being not rigid enough or torsion resistant.

As alginate does not adhere to the tray walls, the impression tray should provide mechanical retentions.

Rim-Lock trays with their retention rim are ideally suited for taking alginate impressions (Fig. 3a).

Simple **metal trays without a retention rim** can also be used with wax strips attached to the rim (Fig. 3b).

Furthermore, special adhesives are available for attaining chemical retention between the alginate and the metal wall in addition to the mechanical retention.

With perforated impression trays care should be taken during the removal of the impression. Once the impression material is detached from the perforations, the impression is unusable (Fig. 4).

When selecting the size of the tray, ensure that the tray is large enough (Fig. 5).

The alginate layer between tray wall and dentition should be at least five millimetres; otherwise plastic deformation of the impression can occur when the impression is removed from undercuts.

If the tray fits in the width but not in the length, which is often the case in the lower jaw, the tray can be extended by using a suitable thermoplastic material (Fig. 6).



Fig. 3 a–b: Impression trays with mechanical retention for taking alginate impressions (a) Rim-Lock tray



(b) Metal tray without retention rim but with wax strips attached to the rim.



Fig. 4: Alginate impression material detached from the perforations can hardly be repositioned in the original position.



Fig. 5: It is important to ensure sufficient space, i.e. at least 5 mm, for the alginate material between both the tray wall and the dentition.

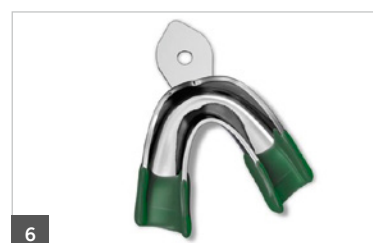

Fig. 6: Dorsally extended lower tray.

5.2 Dispensing and mixing

Prior to dispensing the alginate powder, the sealed container should be shaken to loosen the powder (Fig.7)

The measuring beaker and spoon supplied by the manufacturer should be used to ensure accurate dosing of the alginate powder and water. Other dosing aids lead to incorrect mixing ratios.

With the measuring spoon the powder is removed from the container and any excess powder is smoothed off with a dry spatula (Fig. 8). After the required amount of powder has been added to a dry mixing bowl, the correct amount of water is dispensed in the measuring beaker (one graduation per scoop of powder, see Fig. 9). The water is then added to the powder and should be mixed in quickly and thoroughly. Within the prescribed mixing time (see instructions for use) powder and water are spatulated to a uniformly smooth mixture. Working and setting time specified in the instructions for use are related to a temperature of 23°C. The optimal technique for producing a smooth mixture is to smooth the material against the sides of the mixing bowl when mixing. To facilitate the mixing of alginate, automatic mixing devices have been developed, in which either the prescribed amount of alginate powder and water can be dispensed or prefilled capsules that already contain powder and water can be used.



Fig. 7: The container with the alginate powder should be shaken prior to dispensing the powder in order to loosen it and ensure accurate dosing.

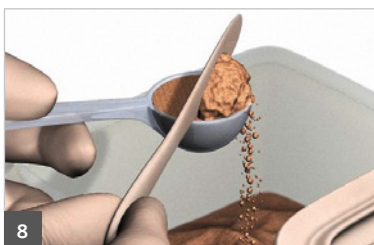

Fig. 8: Smooth off any excess powder with a dry spatula.



Fig. 9: Measuring the required amount of water in the measuring beaker.

5.3 Taking and removing the impression

The mixed alginate is loaded in the impression tray and should be distributed uniformly with a spatula. With a moistened finger the surface of the alginate is smoothed. To improve the accuracy of the impression, use the finger to spread small portions of alginate into the fissures, before inserting the loaded tray (Fig. 10).

When taking lower impressions, the patient's mouth should be kept as fully closed as possible during the few minutes required for the material to set. A wider opening of the mouth causes a slight deformation of the lower arch due to muscle movement and results in an impression that is different to one in the centric jaw relationship.

The impression should remain in the patient's mouth until the alginate has completely set (see instructions for use). If the impression is removed too early, the cross-linking reaction has not yet been fully completed, resulting in permanent plastic deformation. To remove the impression from the mouth, place the index finger on the vestibular rim/excess alginate material and gradually exert pressure (Fig. 11). Avoid using the tray handle as a lever, as the alginate is easily loosened from the tray due to the leverage.

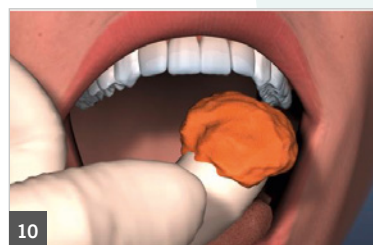

Fig. 10: Before inserting the loaded impression tray, use the finger to spread a small portion of alginate into the fissures to improve the accuracy of the impression.

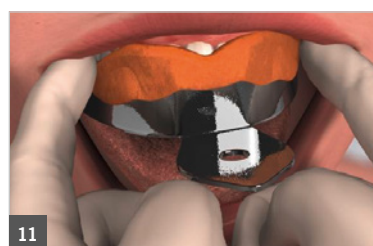

Fig. 11: Release the tray from vestibular by gradually exerting pressure with the fingers on both sides to prevent permanent deformation of the alginate material or loosening the impression from the tray.

5.4 Special features with colour-change alginates

Usage of colour-change alginates provides additional assurance regarding the processing. The end of each individual phase is indicated by a colour change due to the addition of pigments that react to pH-value changes during the setting reaction. Modern materials can indicate all the relevant moments during alginate impression taking with a change of colour. These include the end of the mixing time, the end of the working time (latest moment to insert the loaded tray into the patient's mouth) and the end of the setting time.

Amongst others, the colour change shall avoid the impression being removed from the patient's mouth before the material is completely set. It can also put sensitive patients at ease knowing that the beginning and end of the intraoral setting time is indicated by a colour change.

5.5 Assessing and preparing the impression

After removal from the patient's mouth, the alginate impression is cleaned under running water to remove saliva residues and examined to assess whether it is usable. The dentition and relevant edentulous jaw sections must be fully captured.

Air bubbles in the occlusal surface will be reproduced as protruding plaster bubbles at the finished model and prevent accurate articulation of the models (Fig. 12 a–c).

Alginate caught in extensive undercuts can tear during impression removal, rendering the impression unusable. To avoid tearing block out extensive undercuts, e.g. from suspended bridge elements or fixed retainers, with wax or a suitable 'block out' material prior to impression taking (Fig. 13).

If the impression is usable, it should be poured immediately, as alginate is prone to shrinkage due to evaporation of water. Storage of the alginate impression in water will result in swelling of the impression due to water uptake.

Before sending the impression to the dental laboratory, cut away excess material that is protruding over the dorsal border of the tray (Fig. 14 a).

If this is not possible without impairing the quality of the impression, the impression should be placed with the open area facing downwards. Otherwise there is the risk of the impression material being loosened from the dorsal region of the tray, resulting in deformation of the impression (Fig. 14 b).

The alginate impression should first be tapped against the hand to remove excess water before placing it in a sealable plastic bag – without any moist tissues or similar aids – for sending it to the dental laboratory (Fig. 15).

As maximum accuracy of the model is achieved if the impression is immediately (within 30 minutes) poured, it is advisable to complete further processing directly in the practice.

Thus, loss of additional time, by sending the impression to the lab, can be avoided. This does not apply for modern types of alginate, which allow a storage of the impression for up to five days.

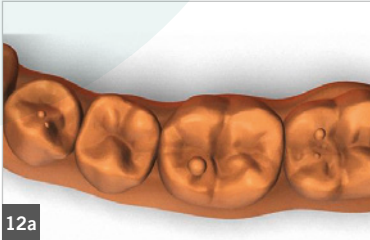

Fig. 12 a: Air voids in the alginate impression result in protruding plaster bubbles on the occlusal surface of the gypsum model.

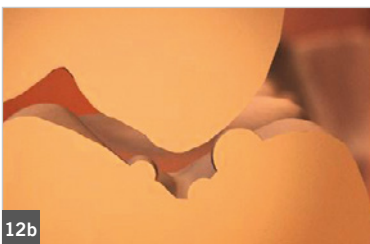

Fig. 12 b–c: The protruding plaster bubbles prevent correct articulation of the upper and lower models (b).



There is no interference with intercuspitation after removal of the protruding plaster bubbles (c).

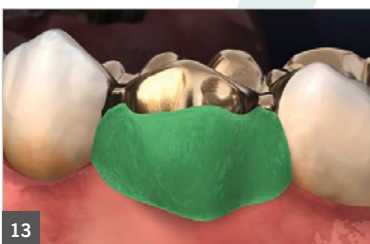
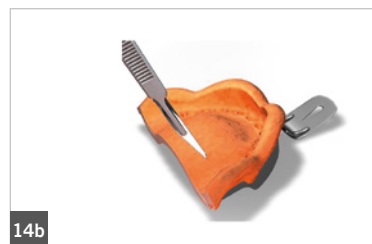

Fig. 13: Blocking out severe undercuts, e.g. the area under a suspended bridge element.



Fig. 14 a–c: To prevent loosening of the impression from the tray by pressure that arises when the impression lies on overhanging alginate material (a)...



... either cut away excess material that is protruding over the dorsal border of the tray (b).



Or, if this is not possible, store the impression with the open side facing downwards (c).



Fig. 15: Store the alginate impression in a sealed plastic bag until it is poured.

6. Model fabrication

6.1 Required materials

When casting an impression of the oral situation (negative mould) with a plastic material, it results in a positive mould, i.e. an anatomical model of the intraoral situation once the material has set.

Dental gypsum is the material of choice for pouring alginate impressions. Other model materials such as cements, resins, ceramics, metals or alloys (metal spraying process, galvanoplastic model fabrication) are not suitable for the fabrication of anatomical models from alginate impressions. Gypsum, chemically calcium sulphate dihydrate in crystalline form ($\text{CaSO}_4 \cdot 2\text{H}_2\text{O}$), adequately fulfils all the requirements of a suitable model material. Furthermore, it is cost-effective and easy to use as a model material.

Dental gypsum is classified into 5 types (I–V) according to the ADA and DIN standard:

- Type I – Impression gypsum
- Type II – Gypsum for articulation and model gypsum
- Type III – Hard gypsum for models
- Type IV – Extra-hard gypsum (high strength, low expansion)
- Type V – Extra hard gypsum (high strength, high expansion)

In general hard gypsum or extra-hard gypsum is used for fabricating anatomical models.

Materials required for the model fabrication:

- Alginate impression
- Dental gypsum powder (gypsum powder must be stored in a sealed container to protect it against moisture)
- Water
- Vacuum mixing unit if available, otherwise a mixing bowl
- Mixing spatula
- Dental lab vibrator
- Plaster trimmer, if necessary
- Base former
- Sticky wax, wax knife, flame

6.2 Preparing the impression

To bind free alginic acid on the surface of the alginate impression, some gypsum powder can be sprinkled into the impression before pouring it (Fig. 16). Some water can be used to better disperse the gypsum powder.

The gypsum powder should be carefully rinsed out after one to two minutes, and the excess water should be removed subsequently.

To facilitate the fabrication of the base and to minimize the later trimming effort, the margins of the model can be marked on the alginate impression with a waterproof pencil (Fig. 17).

Additionally, the lingual opening of lower arch trays can be filled out with wax or silicone (Fig. 18).

6.3 Mixing the dental plaster

Dental plaster can either be mixed manually in a flexible mixing bowl by using a spatula or with an automatic vacuum mixing unit.

The entire equipment that is used for mixing must be completely clean. Residues from a previous mixing procedure could reduce the surface quality of the model and accelerate the setting reaction. Strictly adhere to the powder/water mixing ratio given by the manufacturer.

The ready-mixed plaster slurry should have a creamy consistency and be homogeneous. Entrapment of air voids has to be avoided. Automatic vacuum mixing units are recommended as hand mixing is prone to the inclusion of air voids. The mixing time with an automatic mixing device usually is about 30–45 seconds with a rotational speed of 300–400 rpm.



16

Fig. 16: Some gypsum powder can be sprinkled into the impression and dispersed with a little water to bind free alginic acid on the alginate impression surface.



17

Fig. 17: Marking the model margins with a waterproof pencil.



18

Fig. 18: The lingual opening is filled out with silicone and the model margin defined with a wax strip.

6.4 Pouring the impression

The impression is poured on a dental vibrator to avoid the inclusion of air voids. Initially only small quantities of gypsum are applied with a small instrument to the terminal tooth on one side of the impression. The vibrations carry the plaster to the deepest areas of the dental arch. In this way, the dental arch is filled portion by portion from one side of the impression (Fig. 19a).

Once the whole dental arch is filled with plaster, larger quantities of gypsum can be applied and distributed until the impression is filled to the margin (Fig. 19b).

A sufficient quantity of the remaining plaster, meanwhile slightly firmer, is applied into the base former. The freshly poured impression then is placed into the gypsum in the base former (Fig. 20a).

Any excess material at the sides can be carefully removed with a plaster knife. Model and base fabrication can also be carried out in two separate steps. In the first step the impression is poured and the gypsum allowed to set. In a second step the poured impression is applied into a base of freshly mixed gypsum. In case of a freehand created base, the base should be trimmed into the first shape by using a knife once the gypsum has slightly set and is cuttable (Fig. 20b).



Fig. 19 a: Small quantities of gypsum are applied into the impression from one side. The vibrations carry the gypsum into the deepest areas of the dental arch by avoiding air voids.

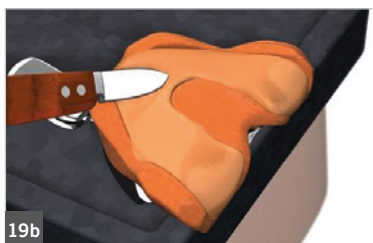

b: Larger quantities are then added until the impression is filled to the margin.

6.5 Removing the impression from the model

As soon as the gypsum has set (see instructions for use), separate the impression from the model. During a prolonged contact of the alginate with the gypsum and an extended storage, water is released from the alginate causing a loss of elasticity and shrinkage. Thus, waiting for too long until separating the impression from the model, makes the removal considerably more difficult and increases the risk of single teeth breaking off.

An alginate impression should therefore never be left on the model overnight.

The base former is removed, then the margins of the impression can be exposed with a plaster knife. The impression now can be carefully loosened circumferentially and separated from the model.



Fig. 20 a: Fabrication of the base with a base former in one step: the freshly poured impression is placed into the freshly filled base former.



Fig. 20 b: Fabrication of the base freehand in two steps. After the plaster in the impression has set, the impression is placed into a freehand created base of freshly mixed gypsum.



Fig. 20 c: Once the gypsum is cuttable, it can be trimmed into the first shape by using a knife.

6.6 Trimming the model

Once the model has been removed from the impression, it can be trimmed to its final shape by using a model trimmer (Fig. 21). The bottom of the model should be level (flat) and parallel to the occlusal surface. The side faces can be square or rounded. When trimming the side faces care should be taken to not to remove too much material.

If the model shall be mounted in an articulator without using the split-cast technique, it is recommended to roughen the surface of the bottom in order to create retentions for the articulation plaster (Fig. 22a).

Alternatively, if the model shall be mounted using the split-cast technique, it is necessary to use a split-cast system during base fabrication (Fig. 22b).

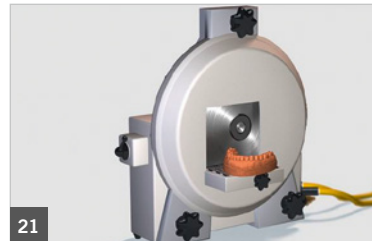

Fig. 21: Trimming of the model with the model trimmer.



Fig. 22a: Preparing the base of the model (a) roughened for rigid mounting.



Fig. 22b: Usage of a splitcast-system, e.g. split-cast system CL-SCS (Kulzer).

7. References

Bornett, M., Schlachter, Ch., Siebert, G.:

Untersuchungen zur Desinfektion von Abformmaterialien in der zahnärztlichen Praxis. Dtsch Zahnärztl Z 35, 902 (1980)

Finger, W., Komatsu, M.:

Elastic and plastic properties of elastic dental impression materials. Dent Materials 1, 129 (1985)

Hansson, O., Eklund, J.:

A historical review of hydrocolloids and an investigation of the dimensional accuracy of the new alginats for crown and bridge impression when using stock trays. Swed Dent J 8, 81 (1984)

Hollinger, O.J., Lorton, L., Krantz, W.A., Conelly, M.:

A clinical and laboratory comparison of irreversible hydrocolloid impression techniques. J Prosth Dent 51, 304 (1984)

Khan, Z., Morris, J.C., v. Fraunhofer, J.A.:

Effect of irreversible hydrocolloid impressions on surface hardness of dental stone. J Prosth Dent 52, 435 (1984)

Körper, K., Ludwig, K.:

Zahnärztliche Werkstoffkunde und Technologie. 2. Auflage Thieme Verlag, Stuttgart 1993

Marxkors, R., Meiners, H.:

Taschenbuch der Zahnärztlichen Werkstoffkunde, 4. Auflage. Hanser Verlag, München 1993

Musil, R., Lueddeckens, H., Oehring, H., Schmidt, H.J.:

Alginatabformung durch eine Peressigsäure- Dampfbehandlung hochgradig desinfizieren. Dental Labor 26, 1083 (1983)

Peutzfeldt, A., Asmussen, E.:

Accuracy of alginate and elastomeric impression materials. Scand J Dent Res 97, 375 (1989)

Viohl, J., Lehmer, P.:

Dimensionsstabilität von Alginatabformungen und Härte der Gipsausgüsse bei Desinfektion. Dtsch Zahnärztl Z 43, 477 (1988)

Wirz, J.:

Der Alginatabdruck in der täglichen Praxis. Quintess Zahntech 7, 199 und 299 (1981)

Wirz, J., Jäger, K., Schmidli, F.:

Abformung in der zahnärztlichen Praxis. G. Fischer, Stuttgart 1993

8. Troubleshooting

Problem	Cause	Remedy
Loosening of the alginate impression from the tray.	<ul style="list-style-type: none"> ■ Insufficient mechanical retention/ physico-chemical bond of the alginate to the tray. ■ Incorrect storage of the alginate impression: the impression lies on alginate material that is protruding over the dorsal border of the impression tray. 	<ul style="list-style-type: none"> ■ Use Rim-Lock trays or attach a wax strip to the rim of a tray without a retention rim. Additionally apply an adequate tray adhesive to the tray. ■ Cut off excess alginate material that is protruding the dorsal edge of the tray. Otherwise store the impression with the open side facing downwards.
Alginate impression tears in the region of the interdental areas or bridge pontics.	<ul style="list-style-type: none"> ■ Too strong undercuts in the region of the interdental spaces or bridge pontics. 	<ul style="list-style-type: none"> ■ Block out extensive undercuts with wax or a suitable 'block out' material prior to impression taking. Don't forget to remove the material afterwards.
Sections of the tray wall shine through the impression material.	<ul style="list-style-type: none"> ■ Incorrect dosing: too much water was used, resulting in too low viscosity of the alginate and thus too little resistance during placement of the impression. ■ Too much pressure was applied during impression taking. ■ No stops provided in the tray. ■ Tray too small or inserted at an angle. 	<ul style="list-style-type: none"> ■ Adhere strictly to the manufacturer's dosing instructions ■ Only apply light pressure when inserting the tray and keep it in place without further pressure. ■ Provide the impression tray with stops before taking the impression. ■ Try in the tray before taking the impression. There should be a uniform minimal distance of 5 mm between tray wall and dentition.
Porous surface of the gypsum model.	<ul style="list-style-type: none"> ■ Setting of the dental plaster impaired by free alginic acid on the surface of the alginate impression. ■ Gypsum powder stored in an open container. ■ Gypsum/alginate combination is incompatible. 	<ul style="list-style-type: none"> ■ Before pouring the impression, sprinkle some gypsum powder into the impression and rinse off carefully after 1–2 minutes under cold running water. ■ Gypsum powder (particularly synthetic gypsum) is susceptible to humidity and always must be stored in a sealed container. ■ In rare cases certain gypsum/alginate combinations are incompatible. It is recommended to use plaster that is recommended in the alginate manufacturer's instructions for use.

Problem	Cause	Remedy
Inaccurate/incomplete reproduction of the occlusal surfaces in the alginate impression and on the gypsum model.	<ul style="list-style-type: none"> ■ Insufficient dynamic pressure to ensure the inflow of the material into the fissures during tray insertion due to a perforated tray. ■ Alginate mixed with a too low viscosity. ■ Too late insertion of the loaded tray into the patient's mouth. The setting reaction of the alginate material was already too advanced. 	<ul style="list-style-type: none"> ■ Use a non-perforated impression tray. ■ Spread small portions of alginate into the fissures with the finger before inserting the loaded tray. ■ Adhere to the dosing instructions. ■ Adhere to the working time.
Protruding plaster bubbles on the occlusal surfaces of the teeth in the gypsum model.	<ul style="list-style-type: none"> ■ Air voids in the alginate impression. 	<ul style="list-style-type: none"> ■ Spread small portions of alginate into the fissures with the finger before inserting the loaded tray.
Fracture of single gypsum teeth when separating the model from the impression.	<ul style="list-style-type: none"> ■ Alginate impression was left too long on the model causing a loss of elasticity and shrinkage. ■ Severe undercuts at the teeth or tilting of the impression during separation from the model. 	<ul style="list-style-type: none"> ■ Remove the impression from the model immediately after the stone has set (approx. 30 minutes/see instructions for use). ■ Loosen the impression/tray circumferentially to remove the impression from the model. Do not use the tray handle as a lever.
Restorations (e.g. acrylic denture, CrCo framework, orthodontic appliance) fabricated on an anatomical model, poured from an alginate impression, fits on the model but not in the mouth.	<p>Permanent deformation of the impression due to:</p> <ul style="list-style-type: none"> ■ too long storage of the impression before pouring it. ■ too long storage of the impression in the disinfectant solution. ■ unnoticed loosening of the alginate impression from the tray wall, e.g. in the dorsal region: excess alginate protruding over the dorsal edge of the tray was not trimmed/the impression was not stored with the open side facing downwards. ■ excessive elastic deformation: <ul style="list-style-type: none"> – incorrect technique during impression removal from the patient's mouth. – too low layer thickness of the alginate due to a too small tray. – excessive pressure exertion during setting of the alginate. – usage of a plastic tray. 	<ul style="list-style-type: none"> ■ Maximum accuracy of the model is achieved when the impression is poured immediately after impression taking. ■ Adhere to the disinfecting time period. ■ Excess material protruding the border of the tray should be trimmed immediately after mouth removal. If this is not possible, the impression should be stored with the open side of the impression facing downwards. ■ The impression should be loosened uniformly and gradually by exerting pressure on the vestibular side with the index fingers. <ul style="list-style-type: none"> – Select a tray that is large enough (min. 5mm distance between tray wall and tooth equator). – After the tray has been placed in the correct position, keep the impression in place without applying further pressure. – Use a metal tray for alginate impression taking.

xantasil® – Impressively convenient.

xantasil – The alginate substitute adapting to your workflow. Not vice versa.

For your flexibility: The long-term dimensional stability provides you with a later and repeated pouring without time pressure.

For your comfort: The impression is convenient for patient and dentist due to its hygienic processing, short time in the mouth and reusability.

For your routine: The especially fast automatic mixing with the Dynamix® speed 2 ensures an excellent and reproducible mixing quality.



Get further information
about alginates!



kulzer.com/alginate

Contact in Germany

Kulzer GmbH
Leipziger Straße 2
63450 Hanau, Germany
info.dent@kulzer-dental.com